

YAMAHA T-700

Natural Sound AM/FM Stereo Tuner
Computer Servo Locked Synthesizer Tuning System
DC NFB PLL Multiplex Demodulator
AM/FM 10-Station Random-Access Preset Tuning
Precise Digital Frequency Readout



OWNER'S MANUAL

Thank you for purchasing the YAMAHA T-700 AM/FM stereo tuner.

CONTENTS	
CAUTION	1/2
CONNECTION DIAGRAM	3
CONNECTIONS	4
FRONT PANEL PARTS AND FUNCTIONS	5/6
MULTIPATH INTERFERENCE	6
RECEIVING FM/AM BROADCASTS	7
INITIAL STATION SET	8
USING THE STATION CARDS	8
TROUBLESHOOTING	9
SPECIFICATIONS	10

IMPORTANT

Please record the serial number of your unit in the space below.

Model: T-700

Serial No.:

The serial number is located on the rear of the chassis.
Retain this Owner's Manual in a safe place for future reference.

WARNING

To prevent fire or shock hazard do not expose this appliance to rain or moisture.

CAUTION (PREPARED IN ACCORDANCE WITH UL STANDARD 1270)

- 1** Read Instructions — All the safety and operating instructions should be read before the appliance is operated.
- 2** Retain Instructions — The safety and operating instructions should be retained for future reference.
- 3** Heed Warnings — All warnings on the appliance and in the operating instructions should be adhered to.
- 4** Follow Instructions — All operating and other instructions should be followed.
- 5** Water and Moisture — The appliance should not be used near water — for example, near a bathtub, washbowl, kitchen sink, laundry tub, in a wet basement, or near swimming pool, etc.
- 6** Carts and Stands — The appliance should be used only with a cart or stand that is recommended by the manufacturer.
- 7** Wall or Ceiling Mounting — The appliance should be mounted to a wall or ceiling only as recommended by the manufacturer.
- 8** Ventilation — The appliance should be situated so that its location or position does not interfere with its proper ventilation. For example, the appliance should not be situated on a bed, sofa, rug, or similar surface that may block the ventilation openings; or placed in a built-in installation, such as a bookcase or cabinet that may impede the flow of air through the ventilation openings.
- 9** Heat — The appliance should be situated away from heat sources such as radiators, stoves, or other appliances that produce heat.
- 10** Power Sources — The appliance should be connected to a power supply only of the type described in the operating instructions or as marked on the appliance.

- 11** Power-Cord Protection — Power-supply cords should be routed so that they are not likely to be walked on or pinched by items placed upon or against them, paying particular attention to cords at plugs, convenience receptacles, and the point where they exit from the appliance.
- 12** Cleaning — The appliance should be cleaned only as recommended by the manufacturer.
- 13** Nonuse Periods — The power cord of the appliance should be unplugged from the outlet when left unused for a long period of time.
- 14** Object and Liquid Entry — Care should be taken so that objects do not fall into and liquids not spilled into the inside of the appliance.
- 15** Damage Requiring Service — The appliance should be serviced by qualified service personnel when:
 - A. The power-supply cord or the plug has been damaged; or
 - B. Objects have fallen, or liquid has been spilled into the appliance; or
 - C. The appliance has been exposed to rain; or
 - D. The appliance does not appear to operate normally or exhibits a marked change in performance; or
 - E. The appliance has been dropped, or the cabinet damaged.
- 16** Servicing — The user should not attempt to service the appliance beyond those means described in the operating instructions. All other servicing should be referred to qualified service personnel.
- 17** Power Lines — An outdoor antenna should be located away from power lines.

- 18** Outdoor antenna grounding — If an outside antenna is connected to the tuner, be sure the antenna system is grounded so as to provide some protection against voltage surges and built up static charges. Section 810 of the National Electrical Code, ANSI/NFPA No. 70 — 1981, provides information with respect to proper grounding of the mast and supporting structure, grounding of the lead-in wire to an antenna discharge unit, size of grounding conductors, location of antenna-discharge unit, connection to grounding electrodes, and requirements for the grounding electrode.

EXAMPLE OF ANTENNA GROUNDING AS PER NATIONAL ELECTRICAL CODE INSTRUCTIONS

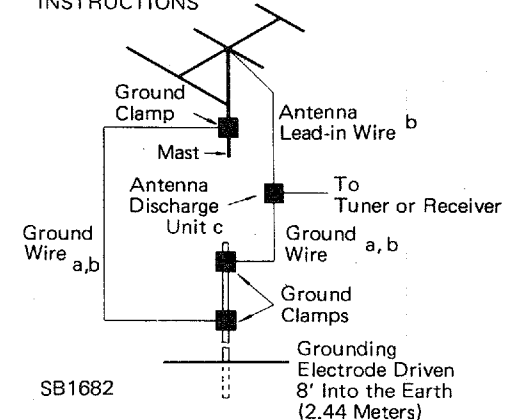

- a. Use No. 10 AWG (5.3 mm²) copper, No. 8 AWG (8.4 mm²) aluminium, No. 17 AWG (1.0 mm²) copper-clad steel or bronze wire, or larger, as ground wire.
- b. Secure antenna lead-in and ground wire to house with stand-off insulators spaced from 4 feet (1.22 meters) to 6 feet (1.83 meters) apart.
- c. Mount antenna discharge unit as closely as possible to where lead-in enters house.

T-700

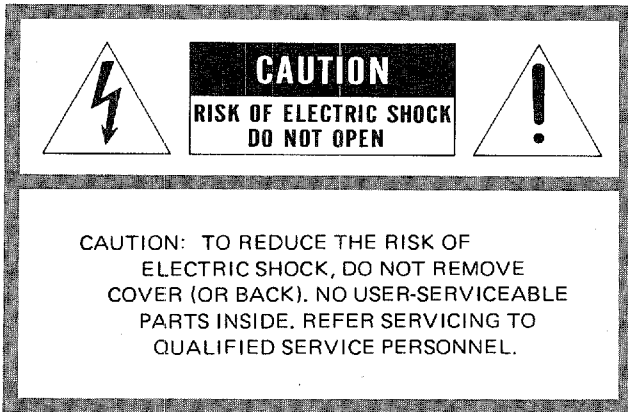

- Explanation of Graphical Symbols

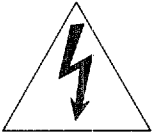

The lightning flash with arrowhead symbol, within an equilateral triangle, is intended to alert you to the presence of uninsulated "dangerous voltage" within the product's enclosure that may be of sufficient magnitude to constitute a risk of electric shock to persons.

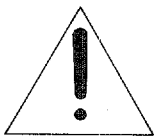

The exclamation point within an equilateral triangle is intended to alert you to the presence of important operating and maintenance (servicing) instructions in the literature accompanying the appliance.

CAUTION: READ THIS BEFORE OPERATING YOUR T-700

- 1** The T-700 is a sophisticated AM/FM stereo tuner. To ensure proper operation for the best possible performance, please read this manual carefully.
- 2** Choose the installation location of your T-700 carefully. Avoid placing it in direct sunlight or close to a source of heat. Also avoid locations subject to vibration and excessive dust, heat, cold or moisture. Keep it away from such sources of hum as transformers or motors.
- 3** Do not open the cabinet as this might result in damage to the set, or electrical shock. If a foreign object should get into the set, contact your dealer.
- 4** To prevent lightning damage, pull out the power cord and remove the antenna cable during an electrical storm.
- 5** When removing the power plug from the wall outlet, always pull directly on the plug; never yank the cord.
- 6** Do not use force when using the switches or knobs.
- 7** When moving the set be sure to first pull out the power plug and remove cords connecting to other equipment.
- 8** Do not attempt to clean the T-700 with chemical solvent as this might damage the finish. Use a clean, dry cloth.
- 9** Be sure to read the "troubleshooting" section for advice on common operating errors before concluding that your T-700 is faulty.
- 10** Keep this manual in a safe place for future reference.

T-700

CONNECTION DIAGRAM

Be sure to connect the left (L) and right (R) channels consistently from component to component.

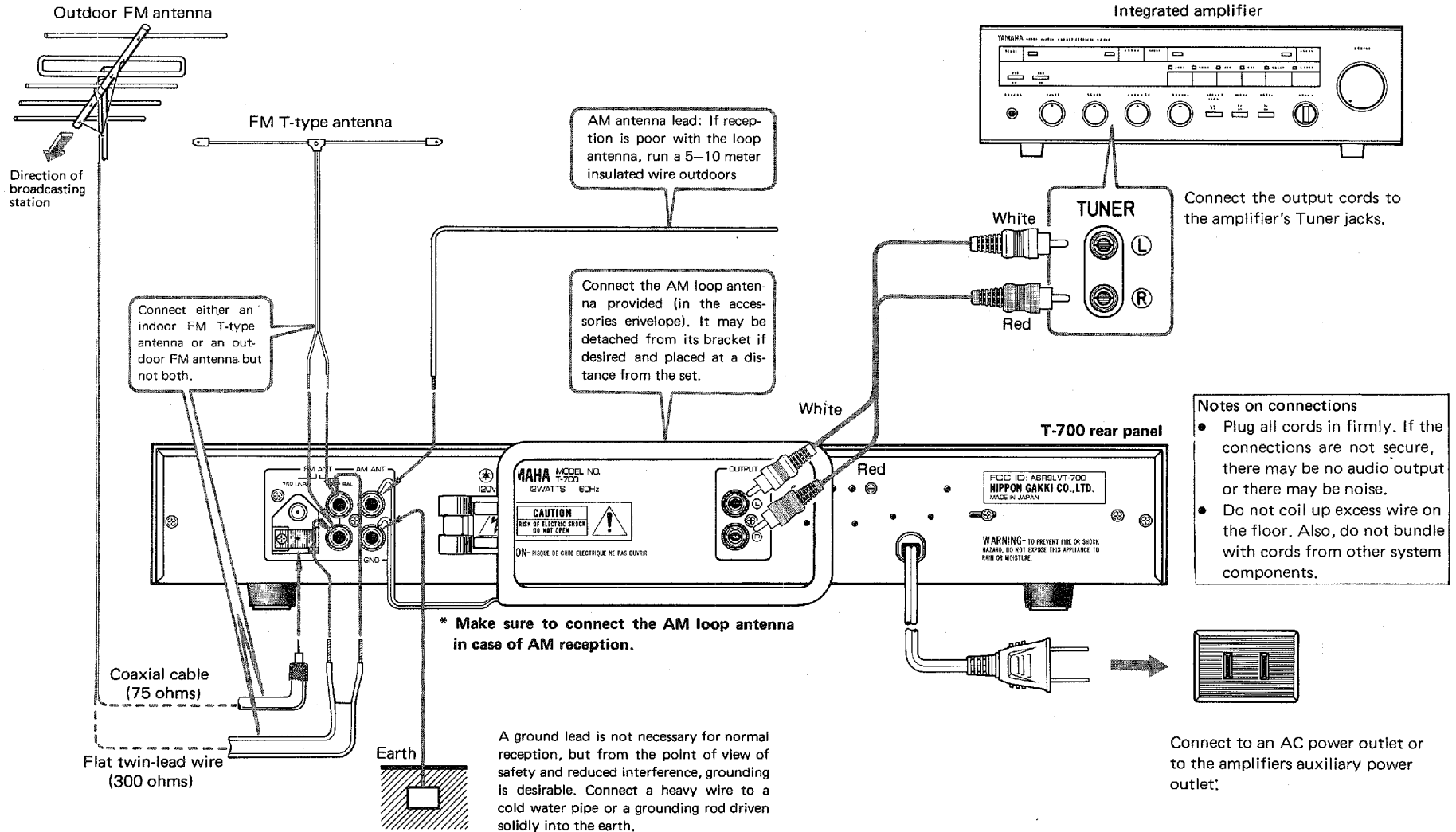

CONNECTIONS

■ CONNECTING THE FM ANTENNA

Choose an FM antenna that is appropriate to the local reception conditions. Consider the distance from the broadcast station and possible interfering objects such as surrounding tall buildings. In cases where there is a strong signal from a local station, a portable T-type antenna is usually adequate. Connect the feeder wire to the 300 ohm terminal, stretch the wire out tight, and turn to obtain optimum reception. Attach to a suitable support such as a wall.

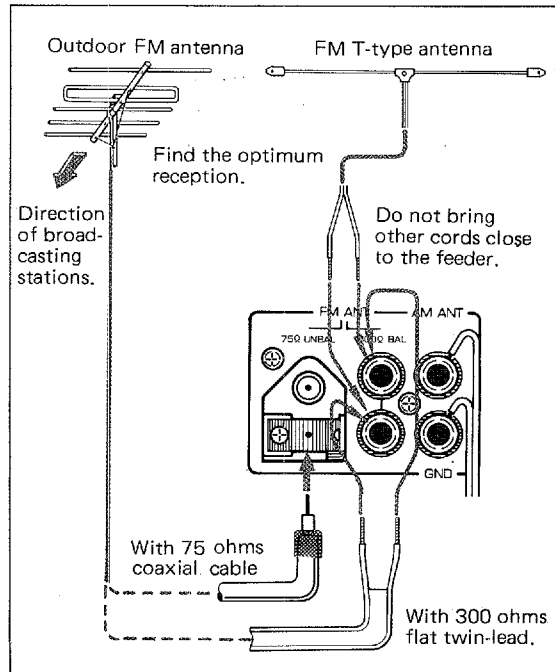

In all but the best reception conditions, an outdoor FM antenna is necessary for best results. Either 300 ohms flat twin-lead wire or 75 ohms coaxial cable may be used. In locations where electrical interference is a problem, coaxial cable is preferable

■ COAXIAL CABLE CONNECTION

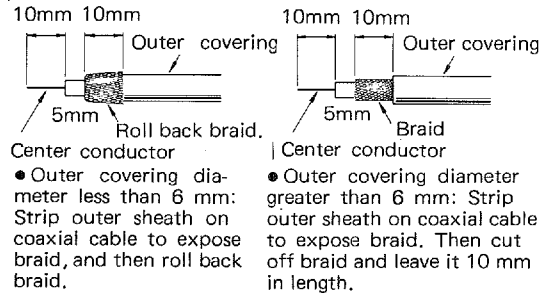

1. Loosen screw of 75Ω unbalanced terminal and make plate free.
2. Insert the center conductor of the coaxial cable into its hole and secure cable with screw so that the braid contacts with plate.

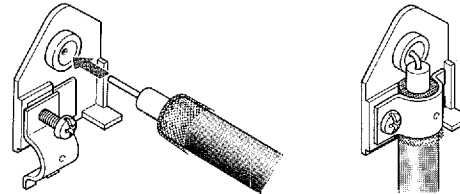

- Insert the center conductor and bend it to the plate side.
- Secure the cable with screw as shown above.

■ CONNECTING THE AM ANTENNA

In many cases it will be possible to get excellent AM reception with the provided AM loop antenna. Attach the antenna leads to the Gnd and AM Ant terminals and rotate the antenna in its bracket for best reception. The loop antenna may also be removed and hung on the wall. If necessary, an outdoor antenna may be used for improved AM reception. Connect a 5-10 meter length of insulated wire to the AM Ant terminal and run it outdoors.

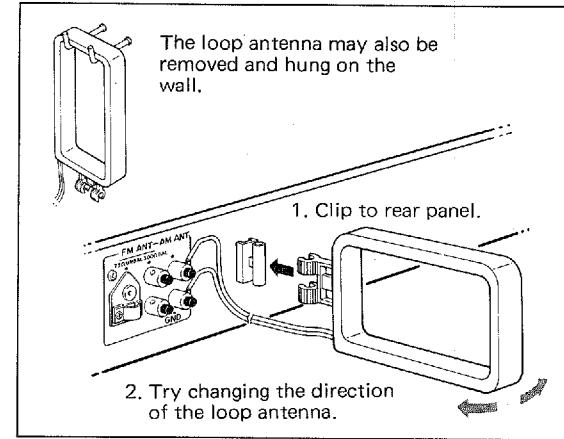

■ NOTE ON FM/AM ANTENNA INSTALLATION

This tuner has both an auto-search type tuning system with 100kHz steps on FM and 10kHz steps on AM and a manual tuning system. Normally, with stations stronger than 10μV (300μV/m on AM when using the loop antenna), auto-search tuning can be used to find and tune in stations automatically. Weaker stations may be tuned in with manual step tuning. Extremely weak stations, however, will not be heard due to the action of the muting circuit. In this case, try rechecking the antenna connections and adjusting the location, direction, and height of the antenna to increase the signal strength to a high enough level for proper reception.

■ CONNECTING THE AMPLIFIER

Use the cable supplied to connect from the output jacks to the tuner input jacks of your amplifier, being sure to observe the left and right channel markings. Also make sure that the connections are secure and that the connecting cable is not bundled with the speaker leads or power cord from the amplifier.

T-700

FRONT PANEL PARTS AND FUNCTIONS

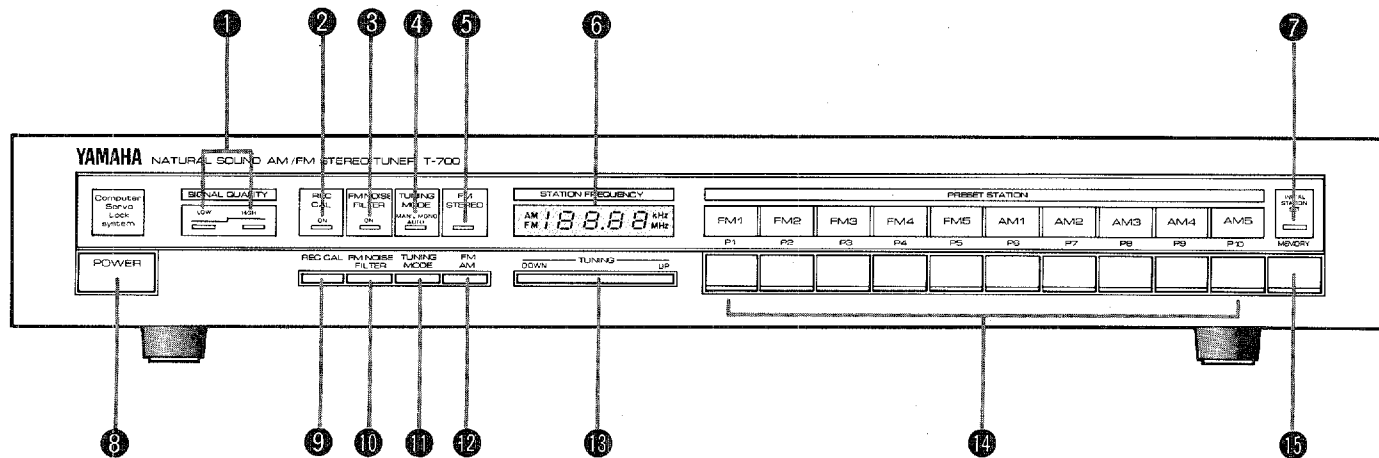

① SIGNAL QUALITY INDICATOR

Indicates the strength of the received station. Adjust the height and direction of the antenna for full indication.

② REC CAL INDICATOR

This indicator begins to flash to remind you that the REC CAL switch ⑨ is pressed.

③ FM NOISE FILTER INDICATOR

This indicator lights to remind you that the FM NOISE FILTER switch ⑩ is pressed.

④ TUNING MODE INDICATOR

The AUTO indicator lights when the TUNING MODE switch ⑪ is set to AUTO, and remains off when the TUNING MODE switch is set to MAN'L.

⑤ STEREO INDICATOR

When an FM STEREO broadcast is being received this indicator lights.

⑥ DIGITAL FREQUENCY READOUT

Shows the frequency of the station tuned in with the TUNING button ⑬ or the PRESET STATION buttons ⑭. The FM frequency range is 87.5 – 108.0MHz, while the AM frequency range is 510 – 1620 kHz.

⑦ MEMORY INDICATOR

Lights for about 3 seconds after the MEMORY button ⑮ is pressed. During this interval the preset memory locations may be programmed.

⑧ POWER SWITCH

When power is turned on illumination lamps above the PRESET STATION button will light, and in a minute tunes in the station selected with INITIAL STATION SET will be turned in. See page 8 for INITIAL STATION SET.

⑨ REC CAL SWITCH

This switch provides a signal for setting record levels prior to recording from the tuner. Pressing the switch activates the REC CAL oscillator to send a 333Hz 50% FM modulated signal to the output jacks. This allows the recording level to be set for a "typical" program level regardless of the current level of the broadcast being received.

* The REC CAL switch takes precedence over all other tuner functions; therefore, it should be left off when not in use.

⑩ FM NOISE FILTER SWITCH

With this switch pressed, high-frequency noise will be cut from weak FM stereo signals.
The FM noise filter will be memorized to together.

⑪ TUNING MODE SWITCH

Sets the Tuning button for either Auto or Manual operation.
The tuning mode (FM stereo or mono) will be memorized to together.

• AUTO Position (FM STEREO)

The TUNING MODE indicator ④ lights, and the auto-search tuning function of the Tuning button ⑬ is activated.

In the AUTO position, any FM stereo broadcast will be received in stereo.

• MAN'L/MONO Position (MONO)

The TUNING MODE indicator is off, and the manual tuning function of the Tuning button ⑬ is activated.

* In the MAN'L/MONO position, even FM stereo broadcasts will be heard in mono.

⑫ FM/AM BUTTON

These switches select either FM or AM broadcasts.

⑬ TUNING BUTTON

Use this button to tune in broadcast stations.

• When the TUNING MODE switch ⑪ has been set to AUTO.

Pressing the DOWN side of the button scans the broadcast band downwards until a station is encountered, then stops with the station perfectly tuned in (Auto-Search Tuning). Pushing the button again scans progressively lower frequencies until the next station is found. When the bottom of the band is reached, the frequency is set to the top of the band and the scan continues downward. Pressing the Up side of the button scans the band upwards in the same way.

• When the TUNING MODE switch ⑪ has been set to MAN'L.

Pressing the DOWN side of the button scans down the band only as long as the button is held, and pressing the Up side scans upwards as long as the button is held. In either case scanning stops when the button is released. Pushing the Tuning button briefly causes the frequency to advance 0.1MHz on FM or 10kHz on AM.

⑭ PRESET STATION BUTTONS

Use these buttons to select the broadcast station preset with MEMORY button.

A total of 10 stations may be preset into the tuner's MEMORY.

It is not necessary to select the proper band (FM or AM) before using one of the PRESET STATION buttons to tune in a station. The band is memorized to together with the station.

The tuning mode (FM stereo or mono) and FM noise filter are also memorized.

⑮ MEMORY BUTTON

Pushing this button causes the indicator on the button to light for 3 seconds. Pressing one of the PRESET STATION buttons ⑭ while the indicator is lit causes the frequency of the station currently tuned in to be memorized. This button is also used to control the Initial Station Set function. You can preselect the station to be tuned in when power is first turned on. For details refer to page 7.

MULTIPATH INTERFERENCE

Multipath is an effect similar to television ghosting; it distorts the received signal and also causes poor stereo separation and noise. As shown in fig, radio waves which travel directly from the transmitter to the receiving antenna are mixed with waves which reflect off nearby objects such as buildings. Because the path taken by the reflected waves is longer than the direct path, the time required for the waves to arrive at the antenna is also longer. The mixing of the directly received signal and the delayed signal noticeably degrades reception quality. Multipath interference can be greatly reduced by the use of a high-quality directional antenna oriented in the proper direction.

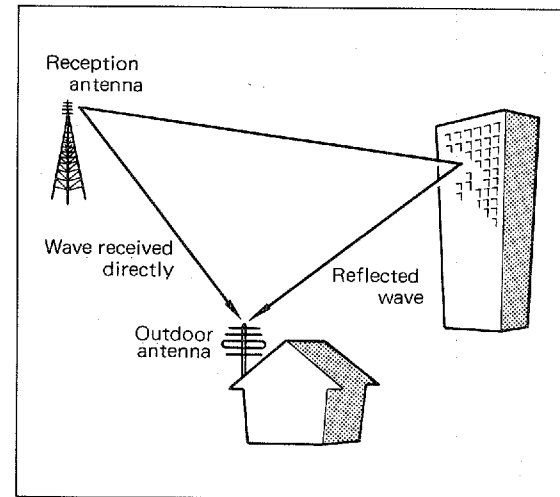

T-700

RECEIVING FM/AM BROADCASTS

■ AUTO SEARCH Tuning

- 1) Press the FM/AM button to select FM or AM.
- 2) Set the TUNING MODE switch to "AUTO".
- 3) Press the DOWN or the UP side of the TUNING button. The tuner will automatically scan the band and stop when a station is found.

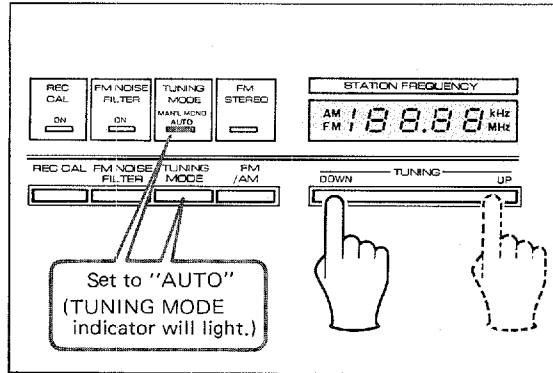

- 4) If the frequency of the desired station has not yet been reached, press the button repeatedly until your station has been tuned in.
- * If no antenna is connected or when an indoor antenna is being used, there may be no stations strong enough to stop the automatic scan. Set the TUNING MODE switch to MAN'L to stop the scan in this case.

■ MANUAL Tuning

When the signal strength of the desired station is very weak, there are cases when the auto search tuning feature will not be able to find the station. In this case manual tuning should be used.

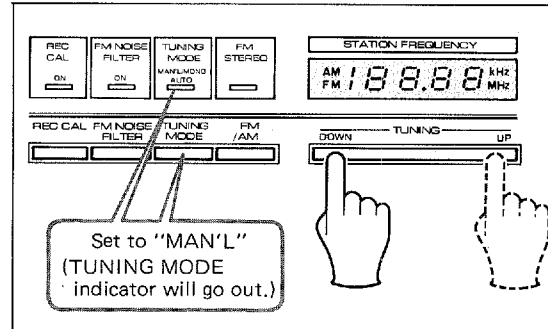

- 1) Press the FM/AM button to select FM or AM.
 - 2) Set the TUNING MODE switch to "MAN'L".
 - 3) Press the DOWN or the UP side of the TUNING button. Release the button slightly before the frequency of the desired station is reached, and use light presses of the button to tune the station in exactly.
- * If the station is weak, however, and interference is heard, setting the selector to mono position will help to bring the station in clearer-without, of course, the stereo effect.

■ PRESET Tuning

In addition to the Auto Search Tuning and Manual Tuning functions of the TUNING button, this tuner has PRESET STATION buttons which provide convenient preset tuning. This one-touch tuning method is easier, faster and more precise than ordinary tuning methods.

● Presetting Stations into the Memory

The following example shows how to preset station frequencies into memory 1.

- 1) Press the FM/AM button to select FM or AM.
- 2) Tunes in the desired station's frequency with AUTO SEARCH Tuning or MANUAL Tuning.
- 3) Press the MEMORY button, and it will light about 3 seconds.
- 4) While it is lit press the desired button on the PRESET STATION buttons. The station's frequency will be memorized and the MEMORY indicator will go out.

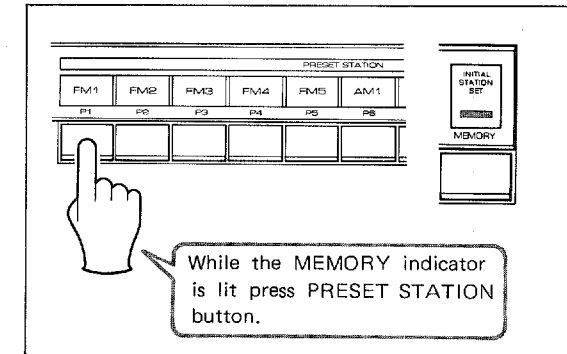

- * When you want to change a previously preset memory, simply repeat the preset procedure given above and the previously memorized frequency will be automatically erased.

● Tuning in a Preset Station

By pressing only PRESET STATION buttons a total of 10 FM and AM stations can be tuned in without having to manually select FM or AM with the FUNCTION buttons.

■ INITIAL STATION SET Feature

You can have the T-700 tune in the station you most often listen to automatically when power is first turned on. This feature is also useful for turning the tuner on with a timer to begin recording an FM or AM broadcast while away.

- 1) Tune the station (by AUTO, MAN'L, or PRESET) tuning that you want to listen to (or record) when power is turned on.
 - 2) Press the MEMORY button and hold it until its indicator begins to flash.
Now, power may be turned off. Now, every time power is turned back on, the selected station will automatically be tuned in.
- * When you want to change a previously preset memory, simply repeat the preset procedure given above and the previously memorized frequency will be automatically erased.

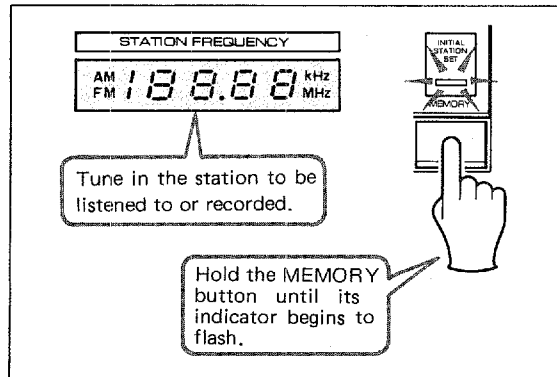

■ Using the Station Cards

Station Cards as shown below come with the T-700.

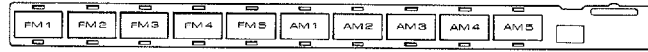

The following cards are provided for your use:

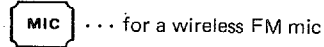

Blank station cards are provided for you to fill in according to the particular stations in your area you wish to program into the preset memory. They can be changed at your discretion.

Inserting, replacing station cards:

1. Remove the card holder.

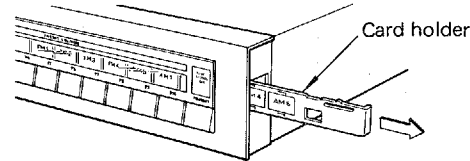

2. Remove the attached card.

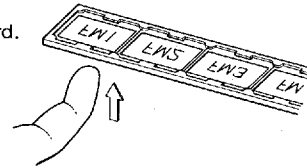

3. After appropriately labelling a station card, remove it from the film sheet and attach it to the card holder.

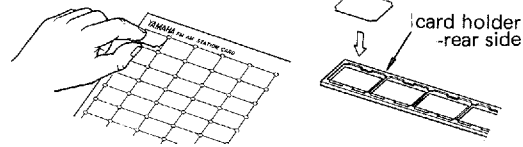

4. Attach the card holder to the tuner.

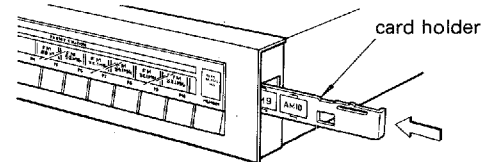

Accessories

Please confirm the accessories included.

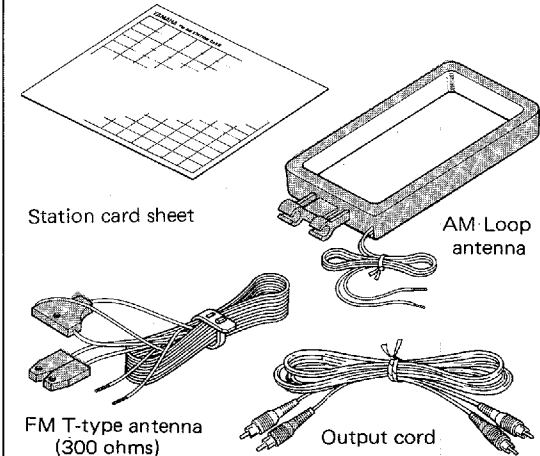

T-700

TROUBLESHOOTING

Before assuming that your tuner is faulty, check the following troubleshooting list which details corrective action you can take yourself without having to call a service engineer. If you have any doubts or questions, get in touch with your nearest Yamaha dealer.

	Fault	Cause	Cure
FM	Crackling sounds from time to time (especially in weak signal areas).	Ignition noise from vehicles.	The FM antenna should be put up as high as possible, away from the road, and a coaxial cable used.
		Noise from thermostats or other electrical equipment.	Attach a noise suppressor to the equipment causing the noise.
	The FM stereo reception is noisy.	Because of the characteristics of FM stereo broadcasts, this is limited to cases where the transmitter is far away or the antenna input is poor.	Check the antenna connections.
			Try using a multiple element FM antenna.
			Set the TUNING MODE switch to the "MAN'L / MONO" position.
	The FM Stereo indicator flickers on and off and reception is noisy.	Insufficient antenna input.	Use an antenna appropriate for the reception conditions in your area.
		Not tuned correctly.	Tune again.
	There is distortion and clear reception can not be obtained even with a good FM antenna.	There is multipath interference.	Adjust antenna placement to eliminate multipath interference.
	No stereo effect even with a stereo broadcast.	The TUNING MODE switch is set to the "MAN'L / MONO" position.	Set the switches properly.
	A desired station can not be tuned in with Auto Tuning.	The station is too weak.	Use a high-quality directional FM antenna.
Use Manual tuning mode.			
Previously preset stations can no longer be tuned in.	The tuner has been unplugged for a long period.	Repeat the preset procedure.	
AM	Insufficient sensitivity.	Weak signal or loose antenna connections.	Tighten the AM loop antenna connections and rotate it for best reception.
	A desired station can not be tuned in with Auto Tuning.		Use an outdoor antenna.
	There are continuous crackling and hissing noises.	These noises result from lightning, fluorescent lamps, motors, thermostats and other electrical equipment.	Use an outdoor antenna and a groundwire. This will help somewhat but it is difficult to eliminate all noise.
	There are buzzing and whining noises (especially in the evening).	Another station is interfering with the received station.	This is impossible to remedy.
A television set is being used nearby.		Move the television a distance away.	

SPECIFICATIONS

■ FM SECTION

Tuning Range	87.5 ~ 108.0MHz
50dB Quieting Sensitivity	
Mono	1.6 μ V (15.3dBf)
Stereo	40 μ V (37.2dBf)
FM Noise Filter On	32 μ V (35.4dBf)
Usable Sensitivity	
(30dB Quieting Mono) 75 Ω	0.8 μ V (9.3dBf)
Image Response Ratio	50dB
IF Response Ratio	90dB
Spurious Response Ratio	70dB
AM Suppression Ratio	60dB
Capture Ratio	
Mono	1.5dB
Alternate Channel Selectivity	55dB
Signal to Noise Ratio	
Mono	89dB
Stereo	84dB
Distortion	
Mono 1kHz	0.05%
Stereo 1kHz	0.07%
Stereo Separation (1kHz)	58dB
Frequency Response	
50Hz to 10kHz	0 \pm 0.2/0.3dB
Subcarrier Product Ratio	50dB

■ AM SECTION

Tuning Range	510 ~ 1620kHz
Usable Sensitivity	250 μ V
Selectivity	25dB
Signal to Noise Ratio	55dB
Image Response Ratio	40dB
Spurious Response Ratio	50dB
Distortion	0.3%

■ AUDIO SECTION

Output Level/Impedance	
FM (100% MOD 1kHz)	500mV/4k Ω
AM (30% MOD 400Hz)	150mV/4k Ω
REC CAL (333Hz)	250mV/4k Ω

■ GENERAL

Power Supply	120V 60Hz
Power Consumption	12W
Dimension (WxHxD)	435 x 72 x 316 mm (17-1/8"x2-7/8"x12-1/2")
Weight	3.8 kg (8.4 lbs)

Specifications subject to change without notice.

SINCE 1887



YAMAHA

NIPPON GAKKI CO., LTD. HAMAMATSU, JAPAN